

HOUSING SPECIFICATION DRAWING

UNCONTROLLED COPY

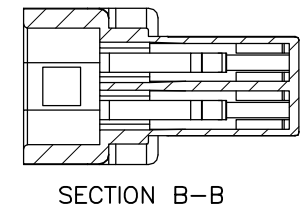
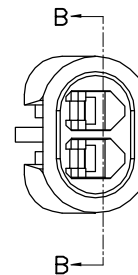
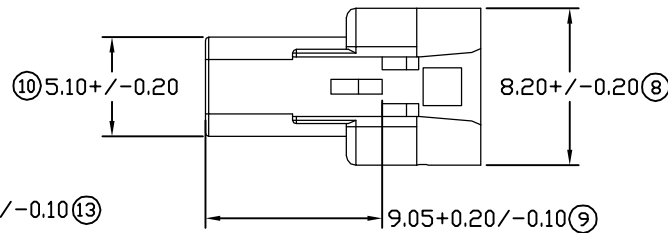
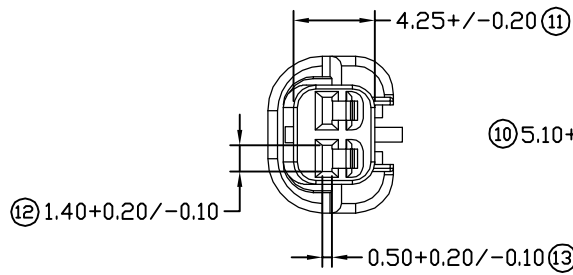
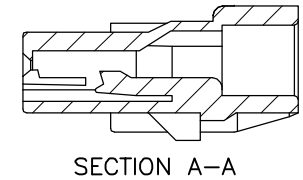
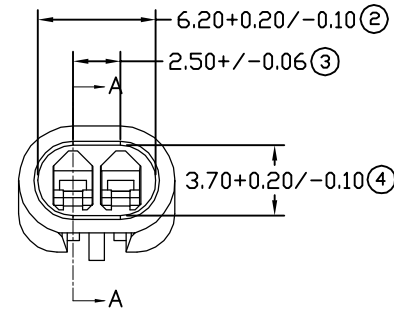
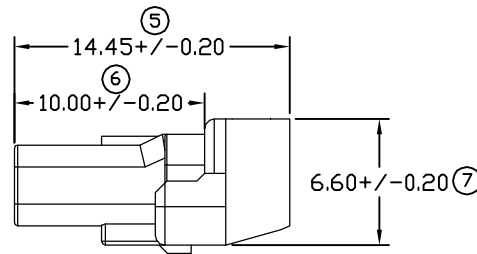
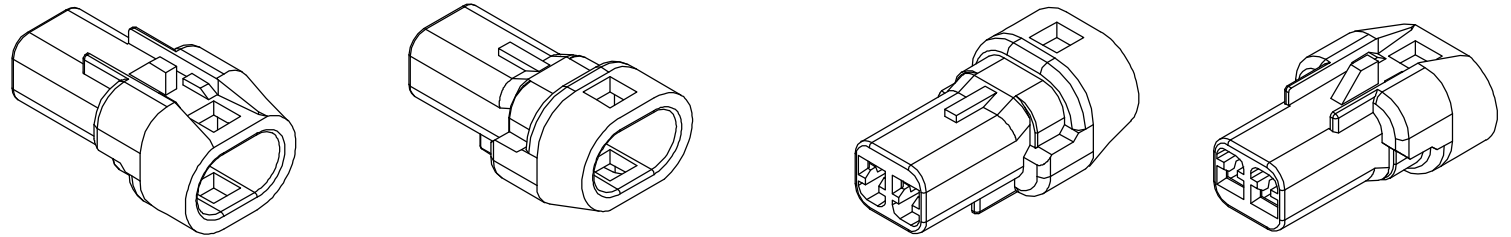

1) PACKING QTY: 1000 PCS/BAG

SPECIFICATION :

FOR REFERENCE ONLY

00	16/4/09	1ST ISSUE
TEMP	4/3/09	FOR TRIAL RUN ONLY
REV.	DATE	AMENDMENT

REVISION:	00
SHEET OF :	1 / 1

DIMENSIONS : MM	
TOLERANCE UNLESS OTHERWISE SPECIFIED:	
X.XXX +/- 0.05	
X.XX +/- 0.10	
X.X +/- 0.20	
X +/- 0.50	
EFFECTIVE DATE :	16/4/09

BLACK	PBT+15%GF	AM050BR-1F02BK
COLOR	MATERIAL	PART NUMBER
EPI Terminals & Connectors Elamp Precision Industry(M) Sdn.Bhd. PART NAME: 2.5 MINI SPLASH PROOF CONN. CRIMP RECEPTABLE		
APPLICABLE (1) TERMINALS (2) HOUSING (1) MX170501 (2) AM050BR-1M02BK, AM050CR-1F02BK		

DWN: KS YEW
 CHK: C.Y CHUANG
 APVD: Y.L CHUANG
 SCALE : FREE
 DRAWING NO: A1537